

USER MANUAL

DIGIIP 1000 Series Owners Manual IPEX1001 & IPEX1002



DigiIP 1000 Series AV/IP

1080P AV over IP 1Gbps Encoder and Decoder with easy setup, no processor required, and with video wall support.

Liberty

www.libav.com 800.530.8998

PRODUCT OVERVIEW

The DigiIP IPEX1000 series distribute, route, and switch 1080p HDMI signals over a standard 1 Gbps network. There is no limit on sources and decoders are limited to a total of 50. No controller needed. ID, name, setup and control is done using the interactive app. DIGI IP 1000 series can work with managed or unmanaged network switches, although commercial grade high performance network switch selection is strongly encouraged

PACKAGE CONTENTS

- IPEX1001
 - (1) Power Supply with international power adapters
 - (2) Phoenix connectors
 - (2) mounting Ears
-
- IPEX1002
 - (1) Power Supply with international power adapters
 - (2) Phoenix connectors
 - (2) mounting Ears

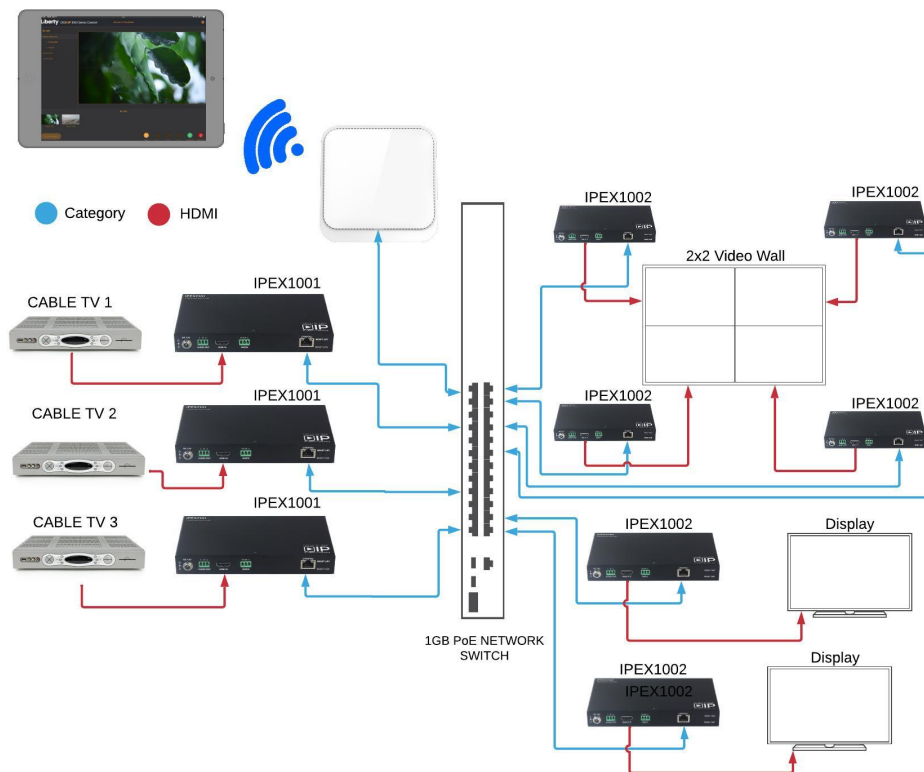

IPEX1001 PRODUCT BREAKDOWN



1. Power LED (Green) :When the green power LED is on the IPEX1001 has power. When the LED is off no power is supplied to the unit.

2. Status LED (Green) : LED is on when an active HDMI input is plugged in. Slow blinking is when the unit has no active HDMI input.

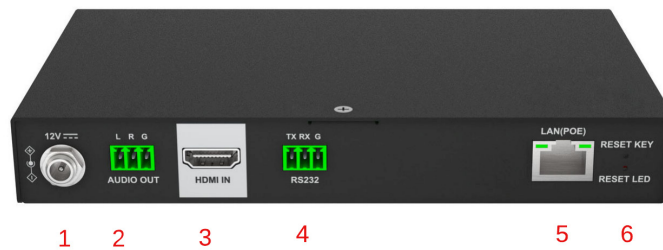

1. Power plug : 12 vdc. Unit supports POE. Unit only needs 1 power source (POE or power adapter)

2. Audio output : Phoenix connector.

3. HDMI source input

4. RS232 : pass through port. (RS232 will pass through to decoder RS232 port)

5. LAN port : POE plug into a Gb network switch

6. Reset button : Press and hold for 5 second to reset unit.

IPEX1002 PRODUCT BREAKDOWN



1. Power LED (Green) :When the green power LED is on the IPEX1001 has power. When the LED is off no power is supplied to the unit.
2. Status LED (Green) : LED is on when an active source is routed to RX. Slow blinking is when the unit has no active source routed to RX.
3. ID Key : Press to manually switch to another source.



1. Power plug : 12 vdc. Unit supports POE. Unit only needs 1 power source (POE or power adapter).
2. Audio output : Phoenix connector.
3. HDMI output : Plug into a display/ projector
4. RS232 : pass through port. (Rs232 will pass through to/from encoder RS232 port)
5. LAN port : POE plug into a Gb network switch
6. Reset button : Press and hold for 5 second to reset unit.

DOWNLOADING THE APP

Search DigiIP 1000 in the app store or visit the IPEX1001 Product Page on www.LibAV.com
The App is available in Apple or Android.

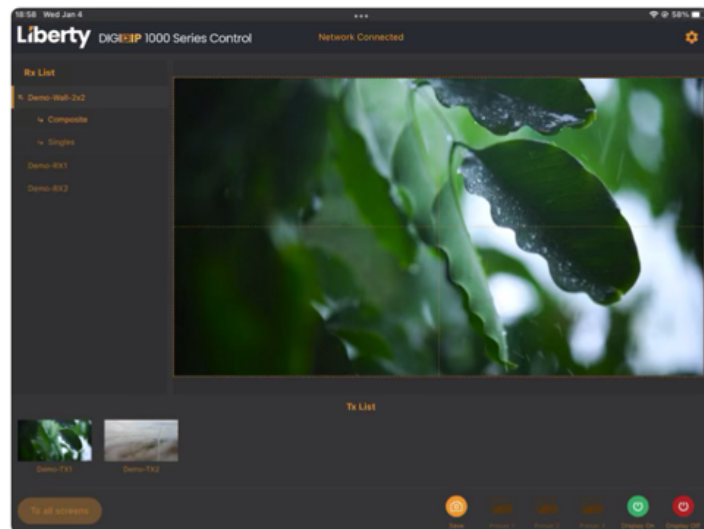

Make sure the tablet is on the same network as the encoders and decoders. Once you open the app, the app will do a search. Below is what it will look like after doing a search.

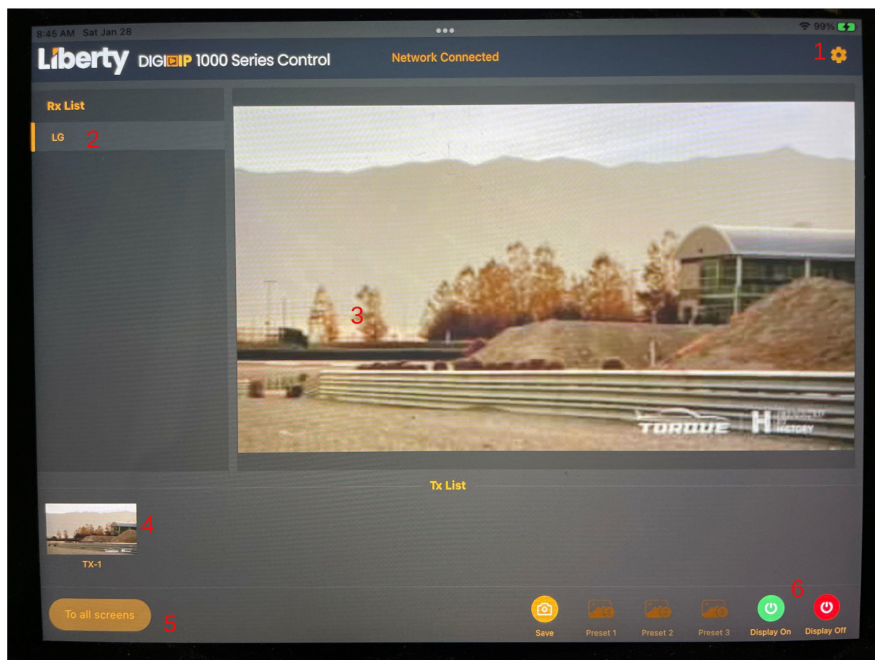

1. System Configuration button: Device settings, Video wall settings, Advanced settings, System information.
2. Decoder list: List of all decoders in the system.
3. Preview window: Preview of decoder selected. To route video click on encoder and drag to preview window.
4. Encoder list: List of all encoders in the system with previews
5. To all screens: Sends Encoder to all decoders. Just drag encoder to button. Only Works if you have under 50 decoders.
6. Power on/off : Turns displays on / off using cec or rs232 commands.

DEVICE SETTINGS

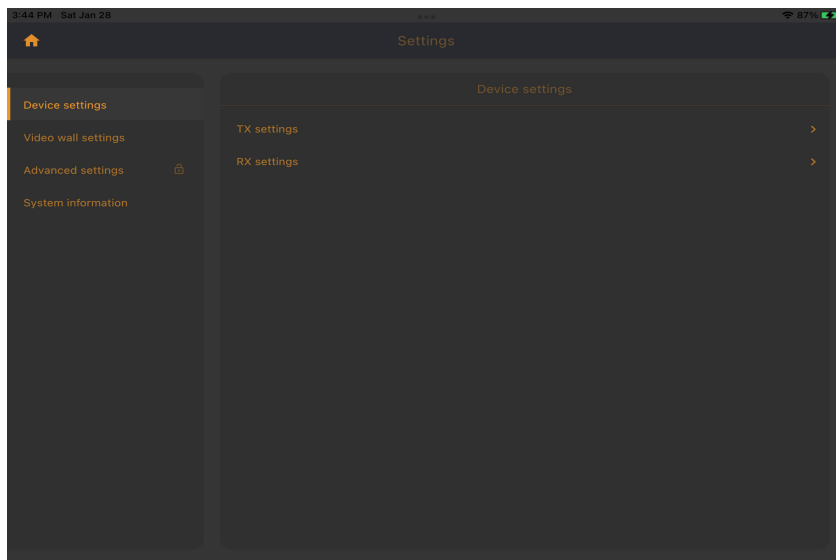

In device settings you can select TX or RX settings. Here you can hide or name & change sequencing.

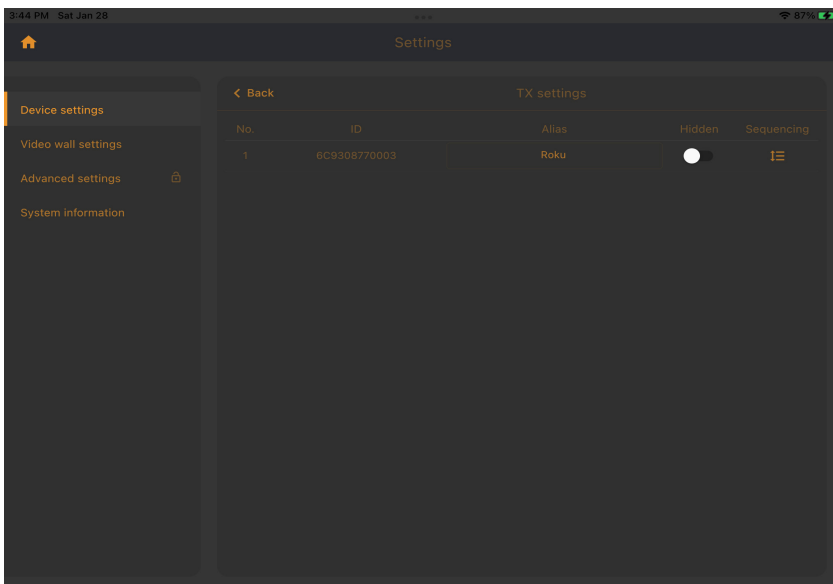

Alias is the name you would like to show up on the main page of the app.

CREATE A VIDEO WALL

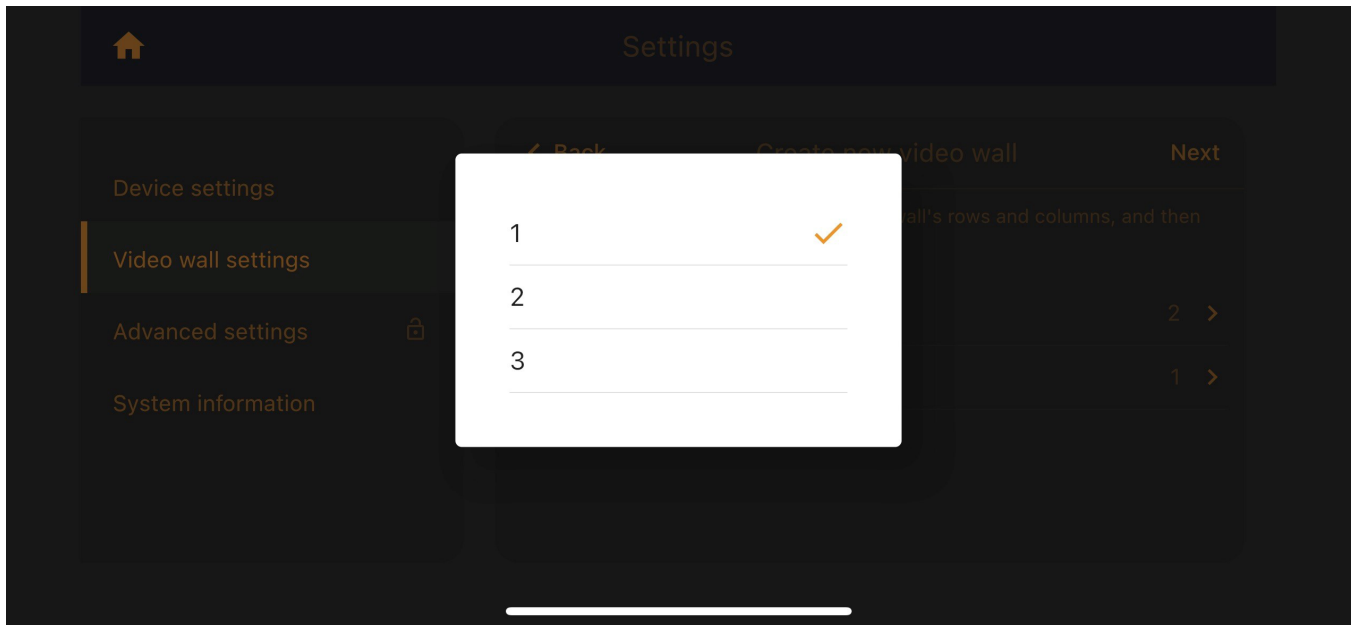

1. First select Create a video wall.
2. Select the number of displays for Row and Column
3. Select Next

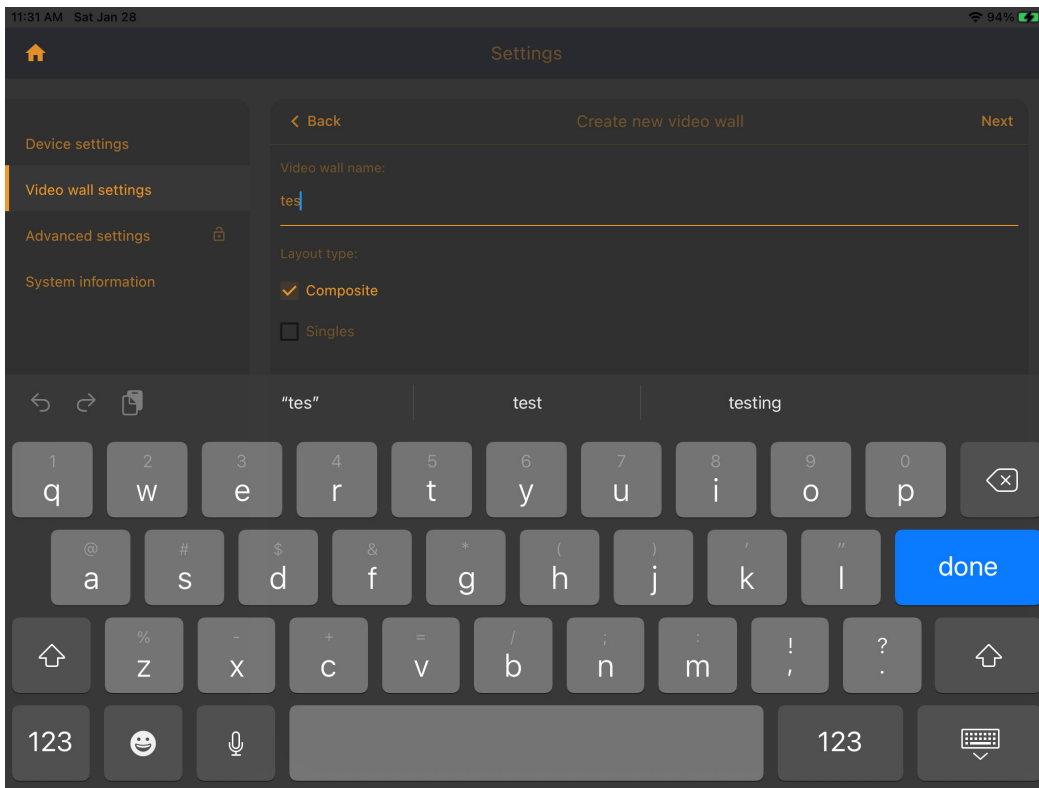

4. Name the video wall and select Composite or single. Composite means video wall and Single means each display is a single display / source.

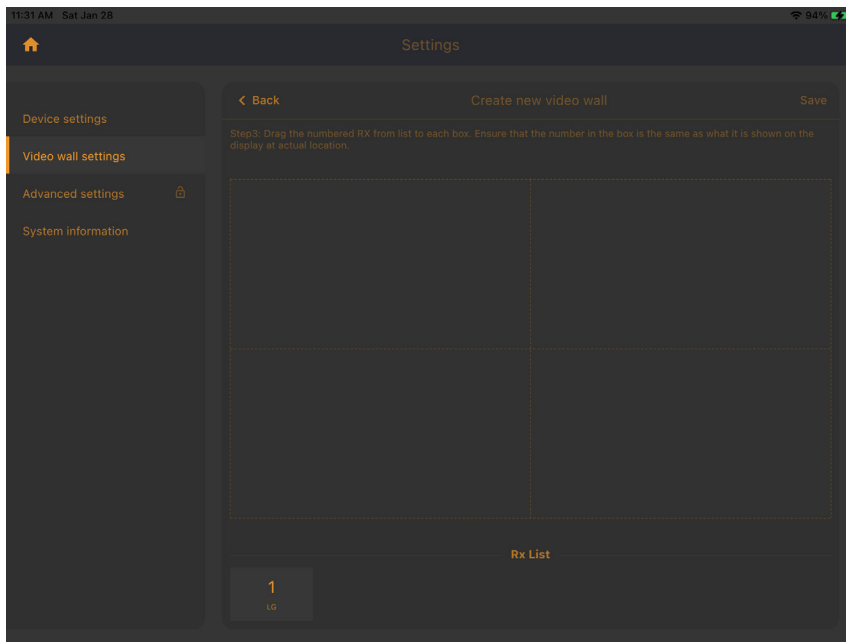

5. Select the decoder and place in the correct box on the video wall layout. Check the display and make sure the number is correct. Once done press Save.

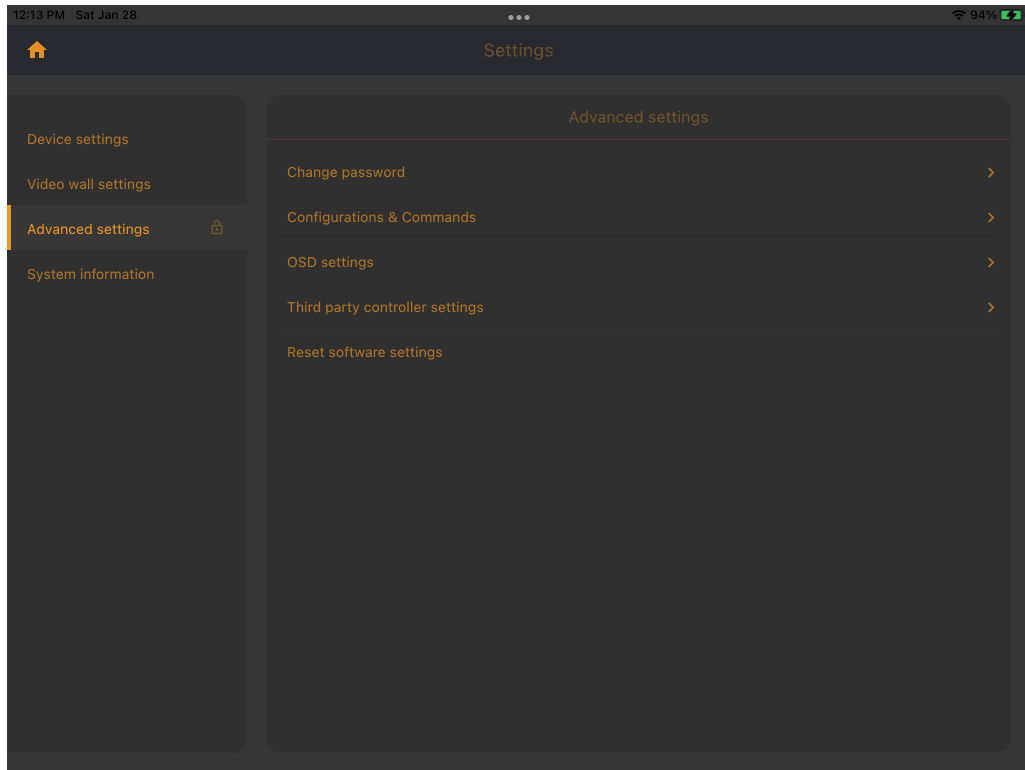

Advanced section allows you to change the following: Password, CEC, RS232, OSD, 3rd party controller settings, and Reset software settings.

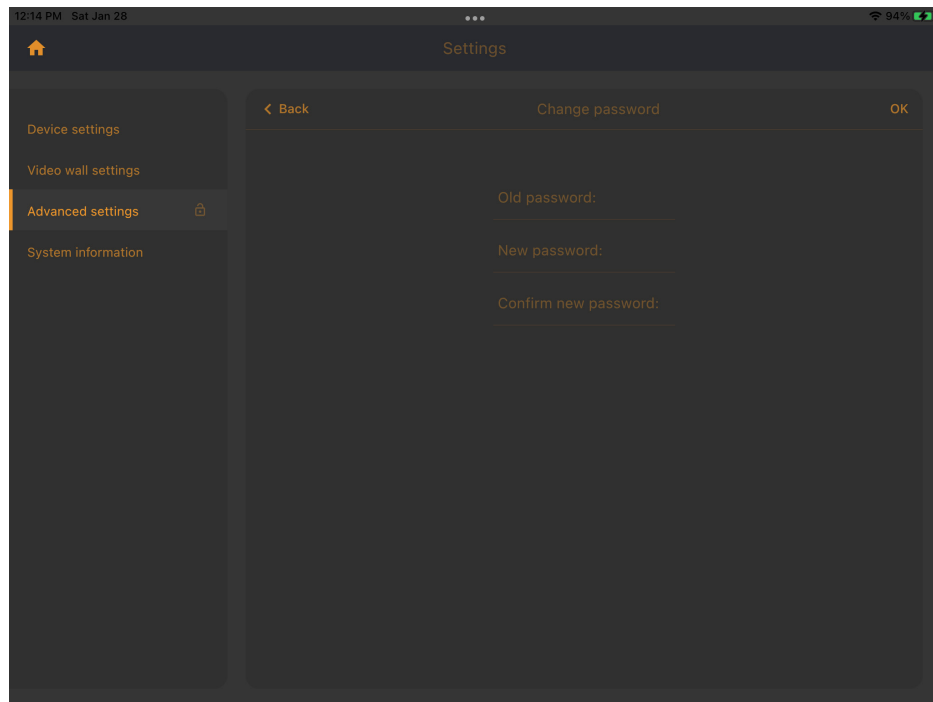

On the password page you can change the password from the default of no password. If you add a password you will be prompted for a password before you can access advanced section.

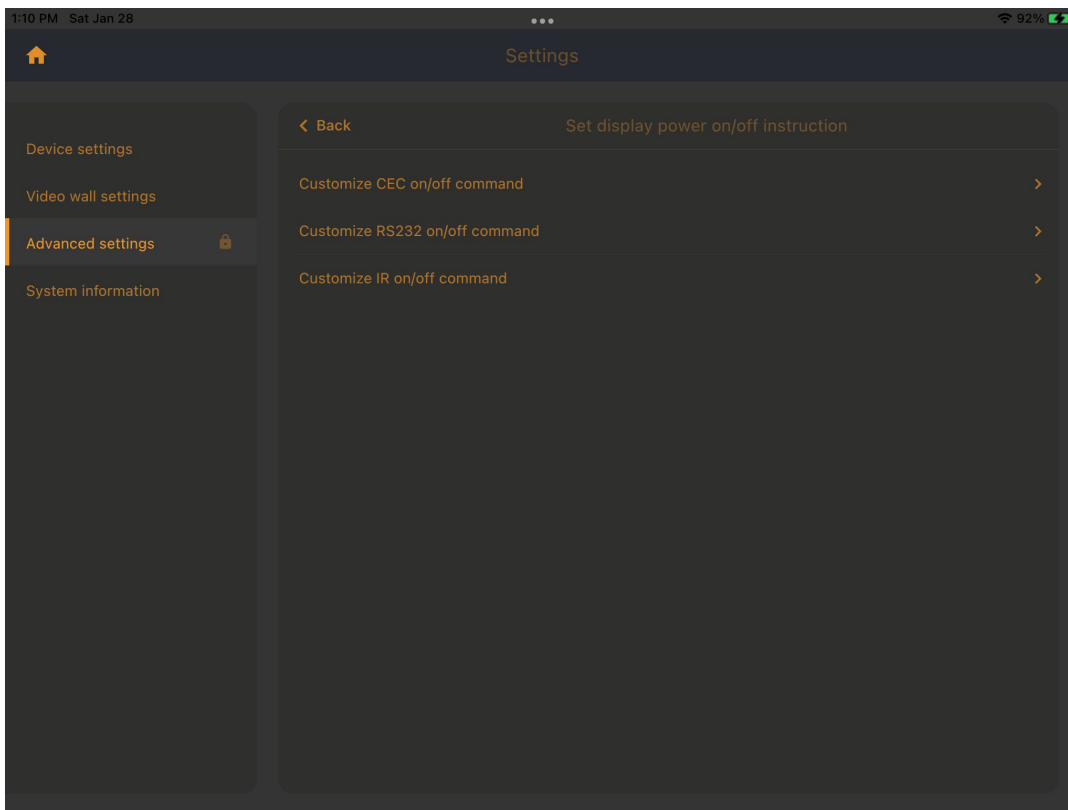

In display power on/off instruction page you can select how you want the displays to be turned on/off. Each section works the same way. Type in the command for on and then off. Below is an example for CEC.

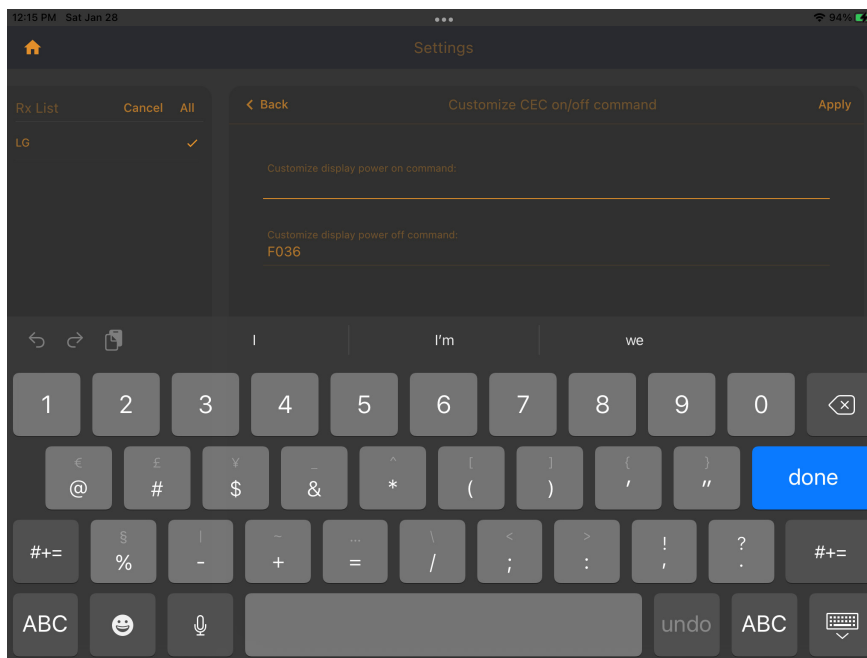

Select the decoder from the left and then type in the on command and then off command. Click Apply and you done.

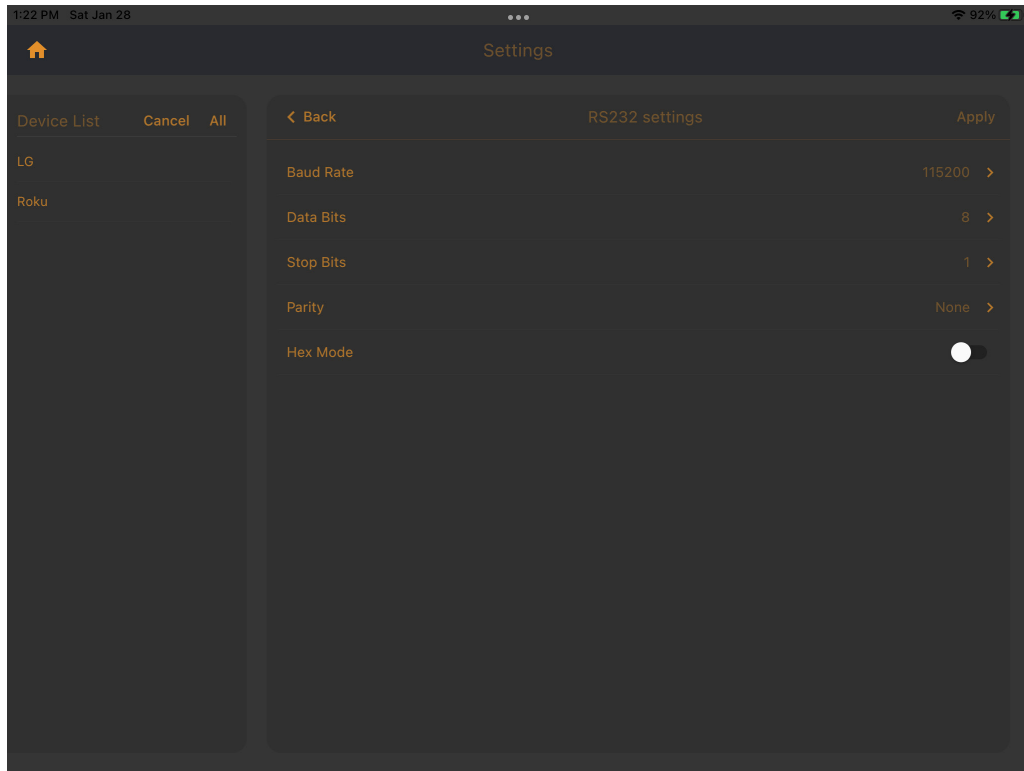

On the RS232 setting page select the device (encoder / decoder) and then set the baudrate for the device. Once done click apply.

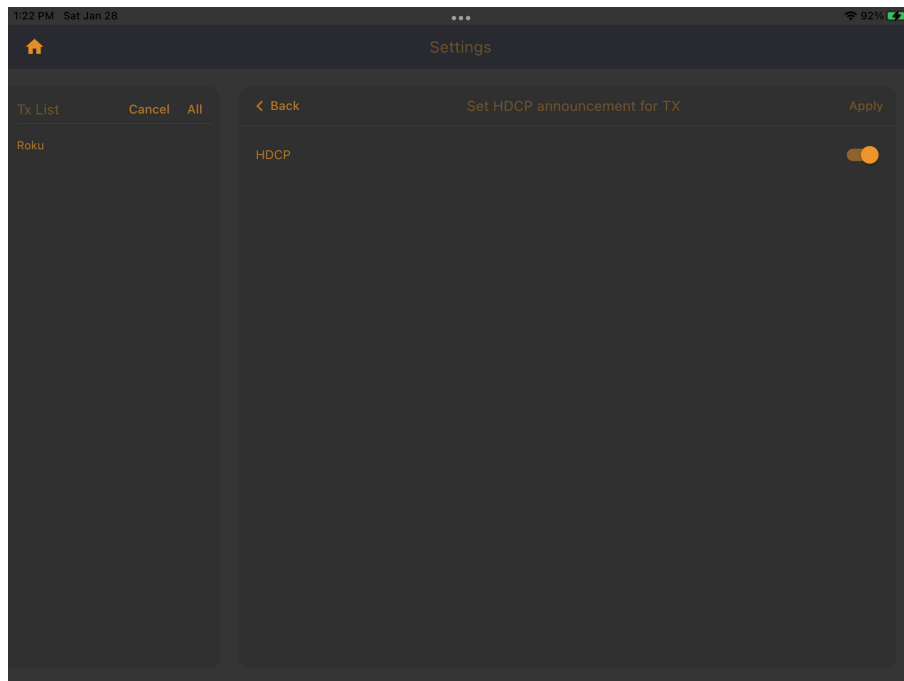

On the HDCP setting page. Select encoder and then turn on or off HDCP. Once done, click apply.

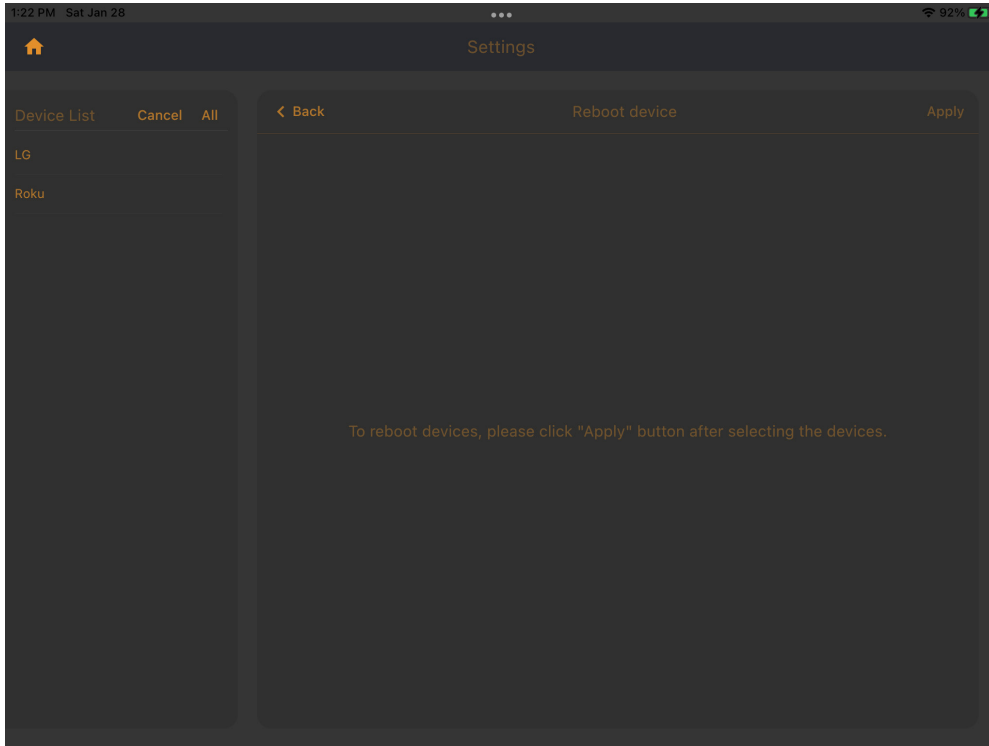

Select either encoder or decoder and then click Apply.

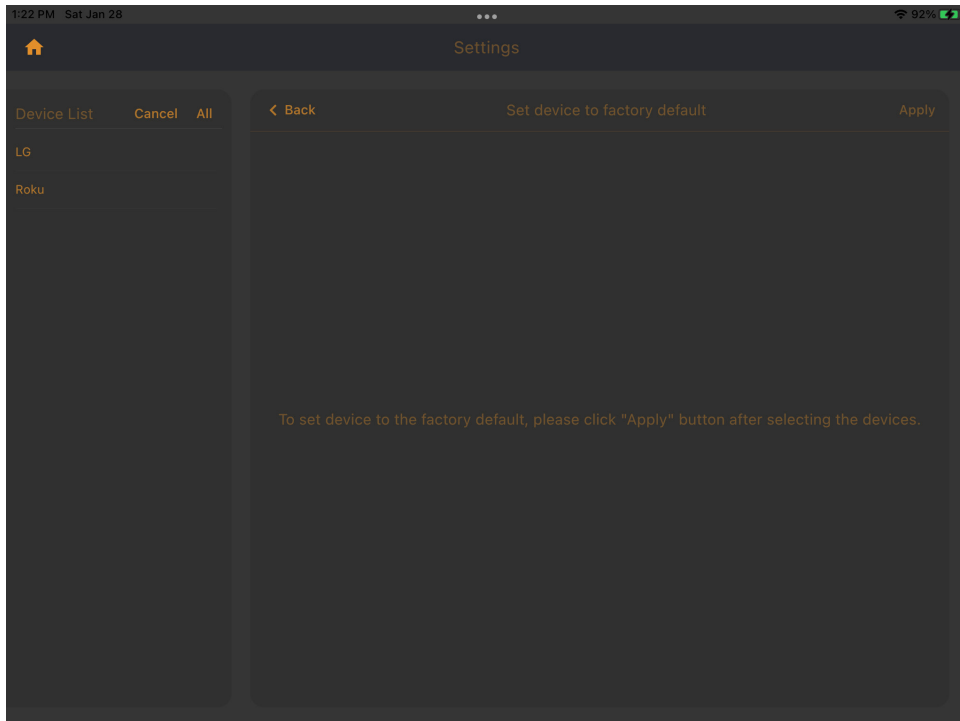

Select either encoder or decoder and then click Apply.

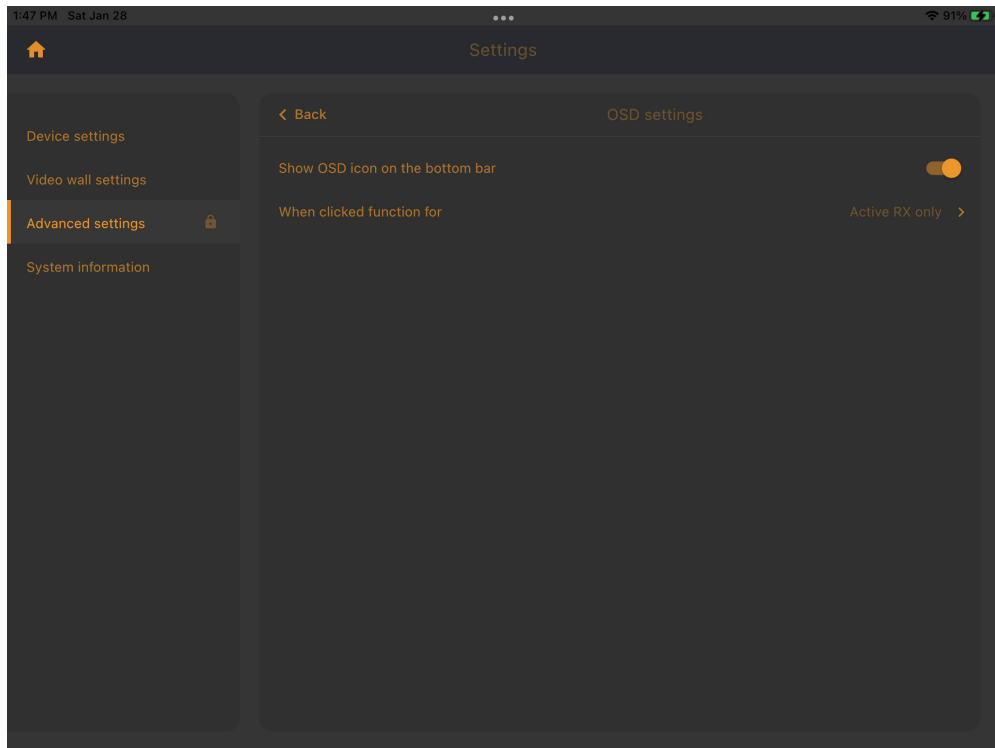

Turn on or off the option for the OSD button to show on the bottom of the home page. Select all decoders or active decoders.

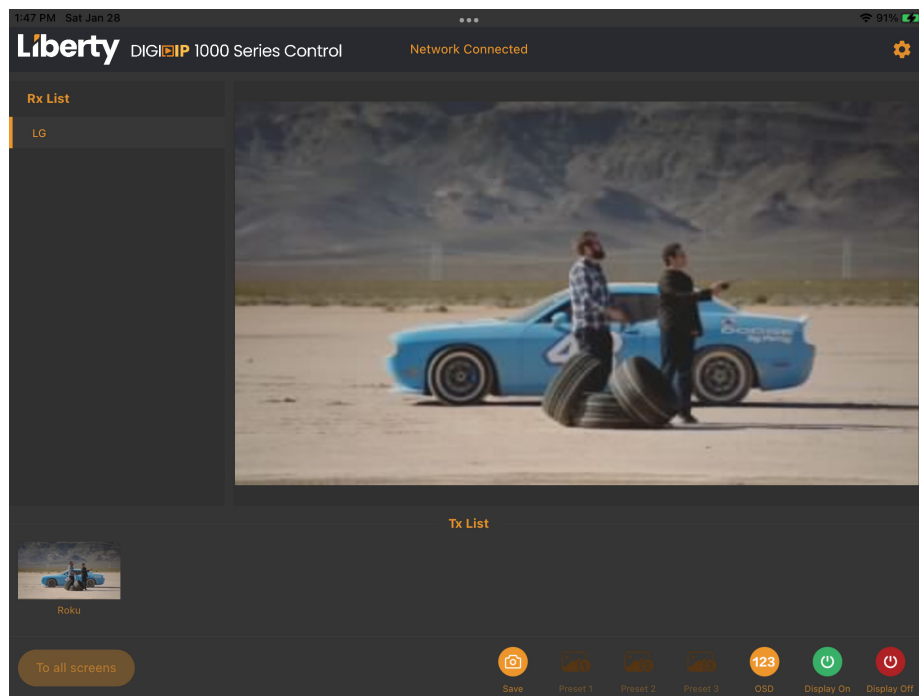

Press OSD button to turn on the OSD information on the decoders. To turn off, resend the source.

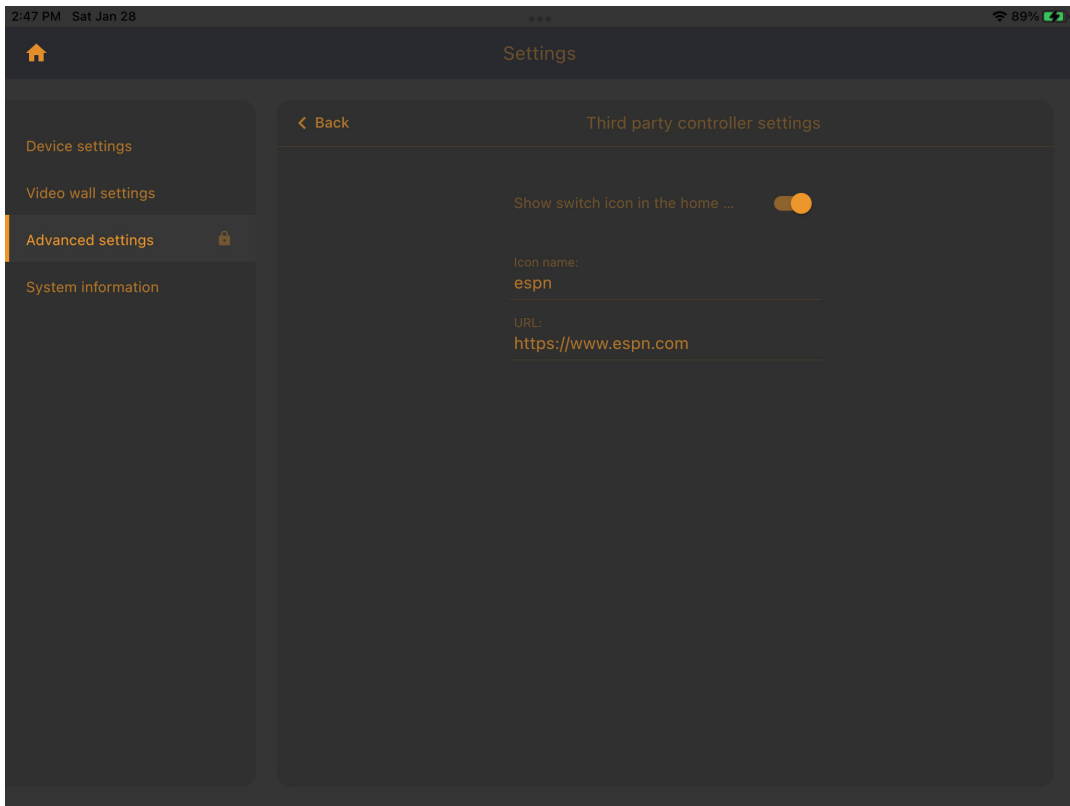

3rd party controller gives you access to another app/browser inside this app. Turn on type in the name and put in the url. Below is screenshot of the home screen.

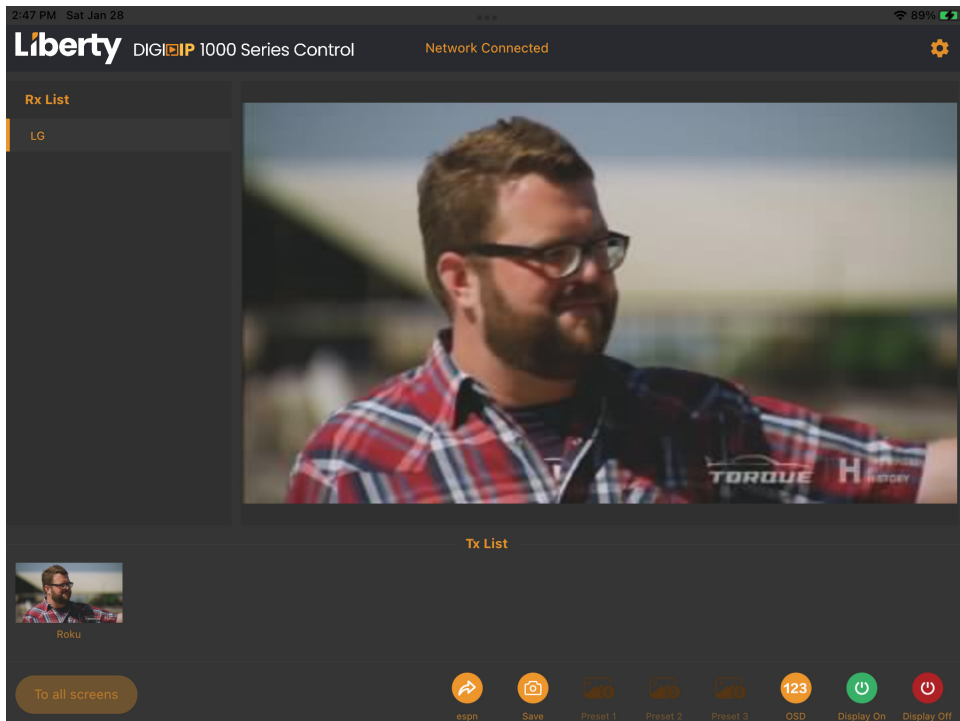

The button opens the browser and takes you to the address you entered. Press back in the upper left hand corner (in the browser)once you are done.

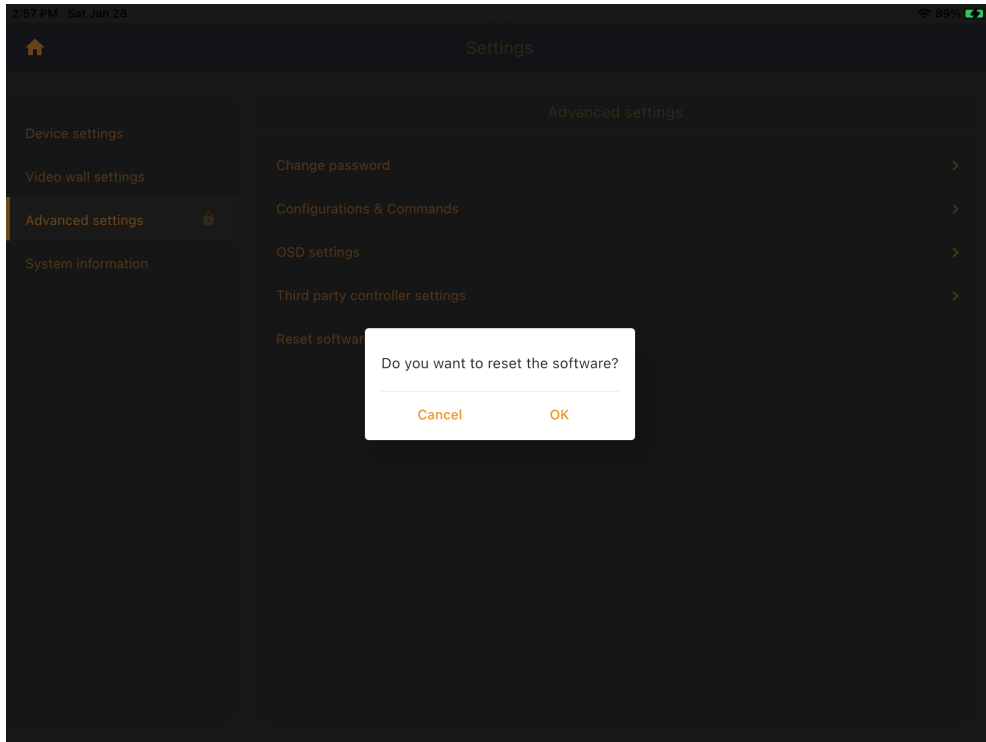

Pressing Reset software settings will open up a pop-up window. If you press yes it will clear all settings on the software. A new search is required for devices to populate.

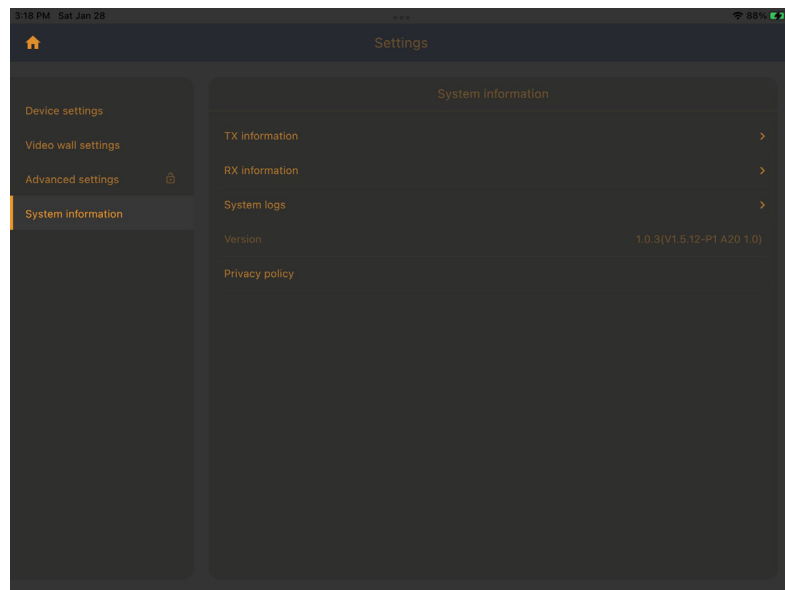

System information area has information on encoders, decoders and logs.

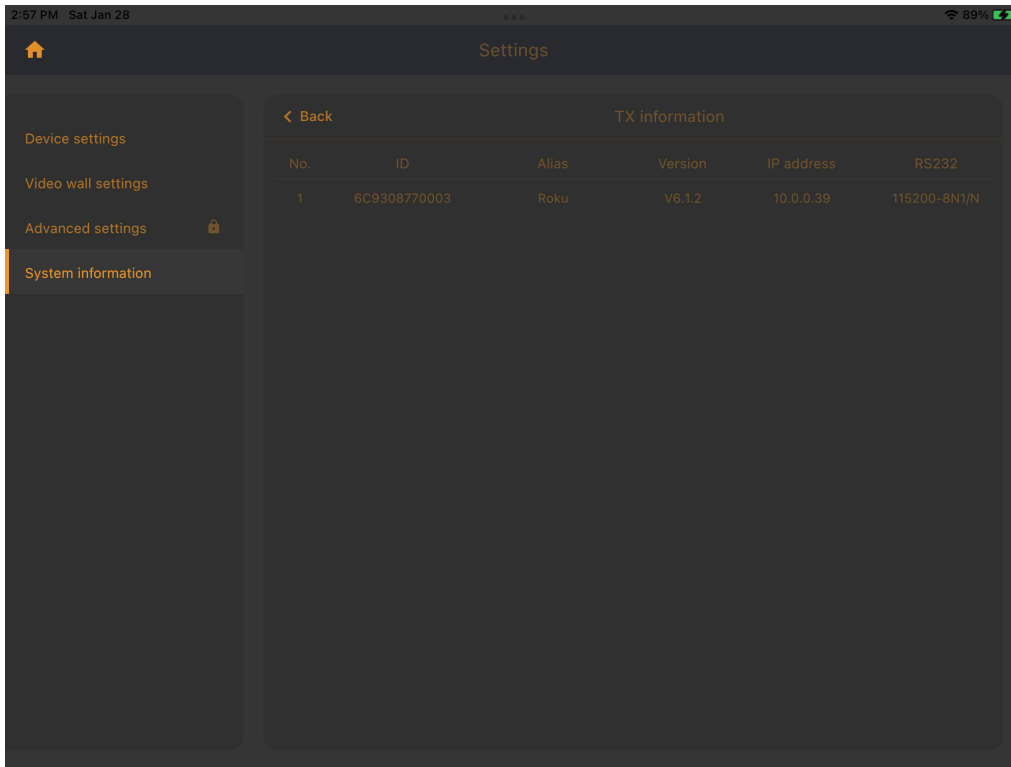

The Tx information screen shows information on all encoders including: IP address, device name, alias name, firmware, rs232 settings.

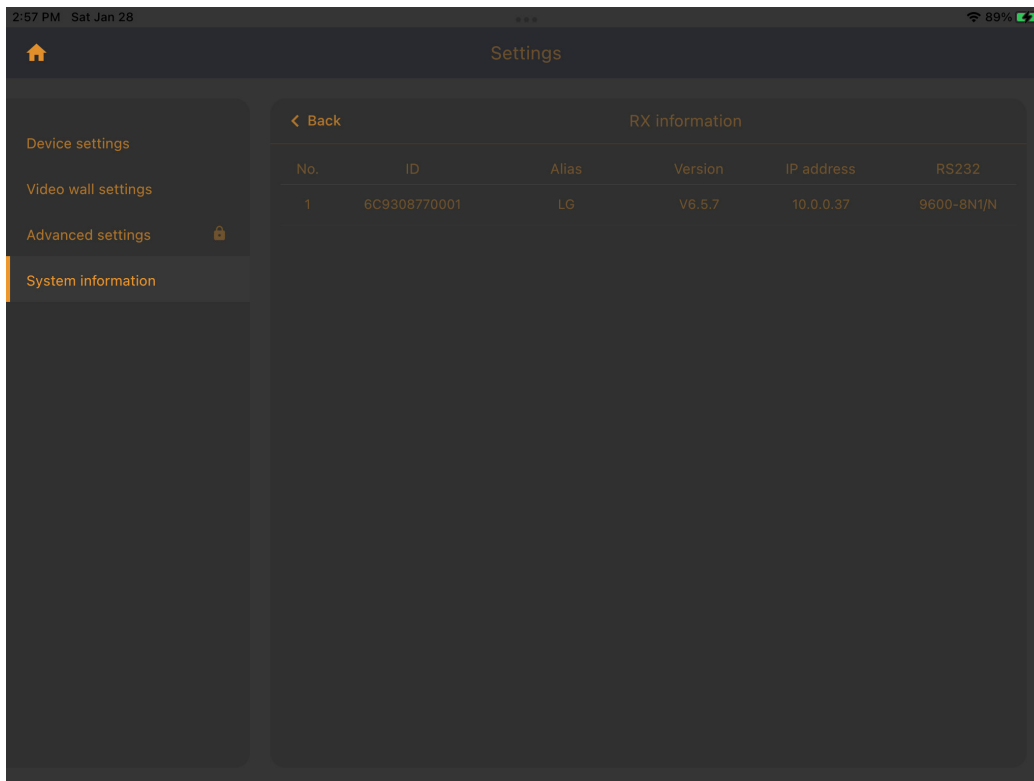

The Rx information screen shows information on all decoders including: IP address, device name, alias name, firmware, rs232 settings.

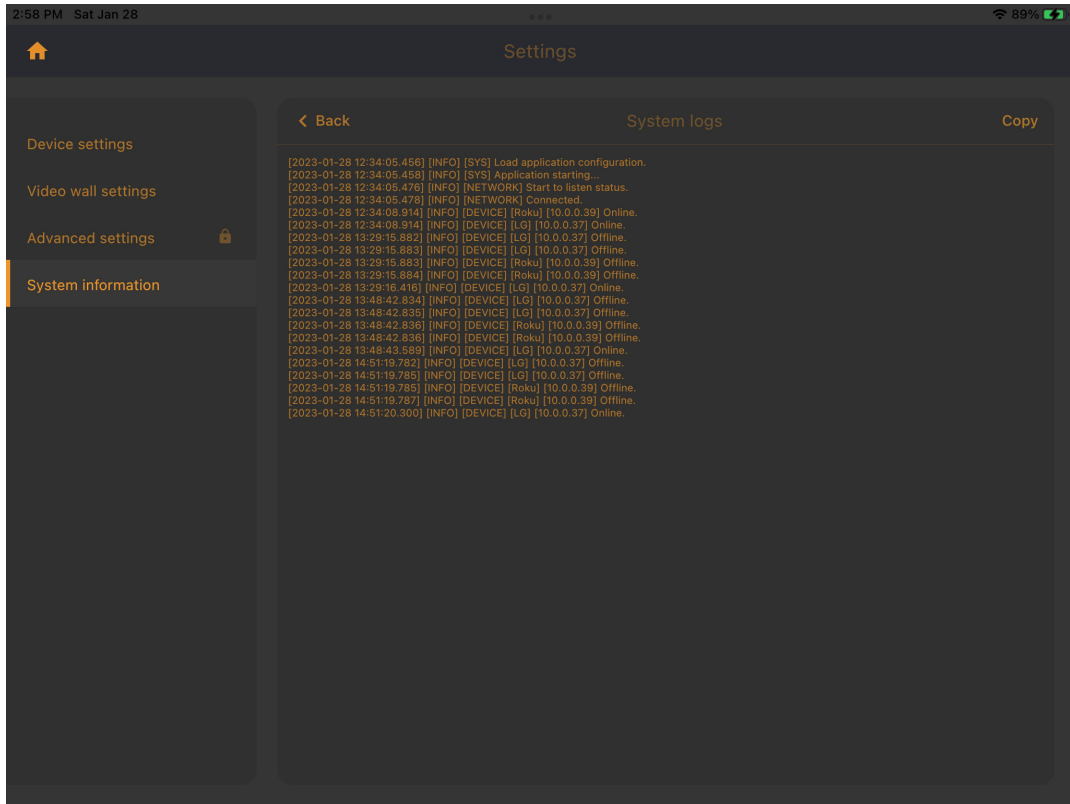

The System logs page shows whether devices are online or offline and any errors. Click copy button to save information to send to support if needed.

TECHNICAL SPECIFICATIONS

Model	IPEX1001 / IPEX1002		
Physical Parameter			
Case Material	IPEX1001: Industrial-grade metal chassis with metal brackets IPEX1002: Industrial-grade metal chassis with metal brackets		
Dimensions	IPEX1001: 175mm [W] x 100mm [D] x 25mm [H] IPEX1002: 175mm [W] x 100mm [D] x 25mm [H]		
Weight	IPEX1001: 600g IPEX1002: 600g		
Power Protection	ESD protection with human body model — ±8kV (Air-gap discharge) & ±4kV (Contact discharge)		
Power Output	DC 12V 1A / POE		
Power Input	AC 100-240V 50/69Hz		
Storage Temperature	32- 140°F / 0- 70°C		
Operating Temperature	32- 113°F / 0- 45°C		
Video Specifications			
Resolution support	1920x1080P 60Hz		
Max Bandwidth	480Mbps		
Video Protocol	H.265 Video Compression		
Audio Format	MPEG-AAC and LPCM Stereo		
Networking			
Standards	1000Base-T		
Data Traffic	Layer 2		
Connectivity			
Inputs	IPEX1001: 1x HDMI 1x RJ45, 1x RS232 IPEX1002: 1x RJ45		
Outputs	1x DC 24V IPEX1001 : 1x audio IPEX1002: 1x audio, 1x HDMI		
Transmission			
Max Distance switch to device	328ft / 100m over CAT5e/6/6a/7		
Max Distance device to device	328ft / 100m over CAT5e/6/6a/7		

Thank you for your purchase.

For technical support please call our
toll-free number at 800-530-8998
or email us at supportlibav@libav.com

Liberty

www.libav.com 800-530-8998